



## The cost function used in 3D mCSEM inversion – is the Born approximation valid?

Leiv-J. Gelius<sup>\*</sup>, University of Oslo, Norway and Martin Tygel, University of Campinas, Brazil

Copyright 2013, SBGf - Sociedade Brasileira de Geofísica

This paper was prepared for presentation during the 13<sup>th</sup> International Congress of the Brazilian Geophysical Society held in Rio de Janeiro, Brazil, August 26-29, 2013.

Contents of this paper were reviewed by the Technical Committee of the 13<sup>th</sup> International Congress of the Brazilian Geophysical Society and do not necessarily represent any position of the SBGf, its officers or members. Electronic reproduction or storage of any part of this paper for commercial purposes without the written consent of the Brazilian Geophysical Society is prohibited.

### Abstract

The validity of the first Born approximation as used in the inversion of marine Controlled Source Electromagnetic (mCSEM) data is investigated. It is demonstrated that a Born based cost-function can lead to potential large errors. As an alternative, the Extended Born approximation is advocated for here. It represents a modest increase in computational effort and gives significantly more accurate results.

### Introduction

In order to speed up the computations during 2D and 3D inversion of mCSEM data, the first order Born approximation (Born, 1933) has been frequently used. Zhigang et al. (2008) applied a Born type of inversion to data from the Troll field in the North Sea. Yuan et al. (2009) inverted data from the Gulf of Mexico employing a numerical scheme where the gradient calculation inside the inversion loop was based on Born.

It is well known that the Born assumption can lead to erroneous errors in case of larger scattering contrasts. This often leads to underestimated values which an inversion scheme tries to compensate for by introducing a larger fictitious anomalous area is introduced by the inversion (blurring). During the recent years a number of scattering approximations beyond Born have therefore been introduced within EM. These include the Extended Born (EB) approximation (Habashy et al., 1993), the Quasi Analytical (QA) approximation (Zhdanov et al., 2000) and the Diagonal Tensor approximation (Song and Liu, 2005). For a more complete discussion of approximate methods the reader is referred to Gelius (2007).

In this paper we demonstrate that the Born approximation is not a good choice when constructing the cost function for inversion of mCSEM data. In a previous study Gribenko and Zhdanov (2007) proposed to employ a Quasi-Analytical (QA) type of cost function. We show here that the use of the even simpler Extended Born approximation should be equally adequate.

### Electric field equation and its approximations

We assume an inhomogeneous 3D anomaly defined by a volume  $V$  embedded in a background model (homogeneous or layered). The total field response in case of EM illumination is described by the electric field equation (Hohmann, 1975)

$$\bar{E}(\bar{r}) = \bar{E}_b(\bar{r}) + \int_D \bar{G}_e(\bar{r}, \bar{r}_0) \Delta \bar{\sigma}(\bar{r}_0) \bar{E}(\bar{r}_0) d\bar{r}_0, \quad (1)$$

where the first term on its RHS is the background field and the second (integral) is the scattered response. The single and double bar notation implies a 3 dimensional column vector and a 3 x 3 matrix, respectively. Here,  $\bar{G}_e$  is the dyadic Green's function and  $\Delta \bar{\sigma}$  the conductivity contrast function of the anomaly explicitly given as

$$\Delta \bar{\sigma} = \bar{\sigma} - \sigma_b \bar{I}, \quad (2)$$

where  $\sigma_b$  is the conductivity of the (homogeneous) background medium and  $\bar{I}$  is the 3 x 3 identity matrix.

### Exact solution

To ensure convergence by the iterative dissipative method (MIDM) (Singer and Fainberg, 1995; Pankratov et al., 1995; Gelius, 2007), Eq.(1) is transformed into the scattering equation

$$\bar{\alpha} \bar{E}_s(\bar{r}) = G_D^c(\bar{\beta} \bar{\alpha} \bar{E}_s) + \sqrt{\sigma_b} \bar{E}_{s,B}(\bar{r}), \quad (3)$$

where  $\bar{E}_{s,B}$  is the scattered field within the Born approximation as given by Eq.(7) and

$$\bar{\alpha} = \frac{1}{2\sqrt{\sigma_b}} [\Delta \bar{\sigma} + 2\sigma_b \bar{I}], \quad \bar{\beta} = \Delta \bar{\sigma} (2\sigma_b \bar{I} + \Delta \bar{\sigma})^{-1}. \quad (4)$$

Moreover, a so-called contrastive operator has been introduced in Eq.(3), i.e.

$$G_D^c(\bar{x}) = \sqrt{\sigma_b} G_D(2\sqrt{\sigma_b} \bar{x}) + \bar{x}, \quad \|G_D^c(\bar{x})\| \leq \|\bar{x}\|, \quad (5)$$

with the integral operator  $G_D$  defined in Eq.(10). Based on the method of successive iterations (Neumann series) the iterative version of Eq.(3) can be constructed as (Gelius, 2007)

$$\bar{\alpha} \bar{E}_s^{(n)}(\bar{r}) = G_D^c(\bar{\beta} \bar{\alpha} \bar{E}_s^{(n-1)}) + \sqrt{\sigma_b} \bar{E}_{s,B}(\bar{r}), \quad n = 1, 2, 3, \dots \quad (6)$$

In this paper, Eq.(6) is employed to compute the exact solution of the scattering problem considered.

### Born approximation

The total field inside the anomalous volume is replaced by the background field. Thus Eq.(1) simplifies to the form

$$\bar{E}_{s,b}(\bar{r}) = \bar{E}(\bar{r}) - \bar{E}_b(\bar{r}) = \int_D \bar{G}_e(\bar{r}, \bar{r}_0) \Delta \bar{\sigma}(\bar{r}_0) \bar{E}_b(\bar{r}_0) d\bar{r}_0. \quad (7)$$

### Extended Born (EB) approximation

Note that Eq.(1) is also *valid within the anomalous region*  $V$  where it can be simplified by the Extended Born (EB) approximation (Habashy et al., 1993) which makes use of the singularity of the Green's function when  $\bar{r} = \bar{r}_0$

$$\bar{E}(\bar{r}) \cong \bar{E}_b(\bar{r}) + \bar{E}(\bar{r}) \int_D \bar{G}_e(\bar{r}, \bar{r}_0) \Delta \bar{\sigma}(\bar{r}_0) d\bar{r}_0 \Rightarrow \quad (8)$$

$$\bar{E}(\bar{r}) \cong \bar{\Gamma}(\bar{r}) \bar{E}_b(\bar{r}), \quad \bar{r} \in V$$

where the EB scattering tensor is explicitly given as

$$\bar{\Gamma}(\bar{r}) = [\bar{I} - G_D(\Delta \bar{\sigma})]^{-1}, \quad (9)$$

in which

$$G_D(\bar{x}) = \int_D \bar{G}_e(\bar{r}, \bar{r}_0) \cdot \bar{x}(\bar{r}_0) d\bar{r}_0. \quad (10)$$

### **mCSEM and the Born approximation**

In later years mCSEM has been introduced as a supplementary exploration technique to seismic. Unlike seismic, mCSEM is rather sensitive to saturation changes in a gas-brine reservoir and can also discriminate better between oil and brine. In case of a hydrocarbon reservoir (characterized by a significantly lower conductivity than the surroundings), guided or refracted diffusive waves are generated at reservoir level. These waves are less attenuated and can be detected at receivers mounted on the seafloor at source-receiver offsets from about 2km and above (Eidesmo et al., 2002) (cf. Fig.1).

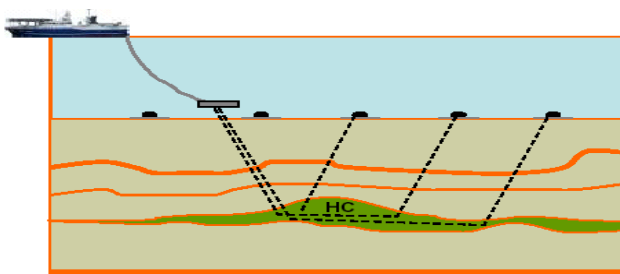

FIG.1 Guided waves inside hydrocarbon reservoir.

The Born approximation fails to describe the physics of mCSEM from several reasons:

- From Eq.(7) that the phase of the electric field inside the anomaly is the same as that of the incident or background field. *This is in conflict with the observed guided-wave phenomenon.*

- A possible field perturbation within the Born assumption can be calculated from the Fréchet derivative (cf. Eq.(7) and considering a change in volume cell  $j$  with center point  $\bar{r}_j$ ):

$$\frac{\partial \bar{E}(\bar{r})}{\partial (\Delta \bar{\sigma}(\bar{r}_j))} = \bar{G}_e(\bar{r}, \bar{r}_j) \cdot \bar{E}_b(\bar{r}_j) \quad (11)$$

Thus, independent of the contrast of the scattering volume. This result may potentially give rise to large errors as demonstrated below when used in a cost-function.

Consider now the simple scattering model as shown in Fig.2. It represents a simplified mCSEM scenario with a homogeneous overburden (no sea layer) and a HED (horizontal electric dipole) source. In the simulations a source frequency of 0.25 Hz was employed. The conductivity of the background medium was set to 0.5 S/m. We consider the inline horizontal electric field component. The results obtained using the Born approximation are compared with calculations employing the exact solution of Eq.(1). In the simulations we assume a *single receiver located at the origin* (cf. Fig.2).

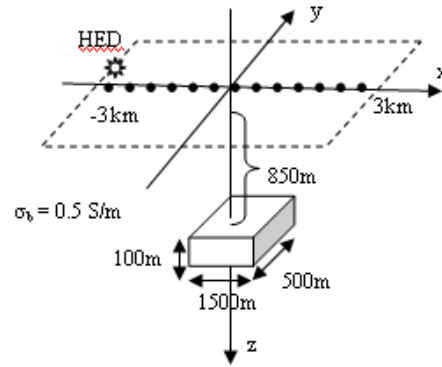

FIG.2 Numerical test model

### Low-contrast case

In the first example the conductivity of the scatterer is initially set to 0.49 S/m, which represents a weak contrast relative the background. We assume a cost-function with a Fréchet derivative based on Eq.(11) and simulate changes in the scattered field in case the contrast changes between 1 and 5%. The relative errors in magnitude and phase when compared with the exact result are shown in Figures 3a and b. Even in this low-contrast case, the errors are not negligible (error in magnitude in the order of 11% and error in phase in the order of 2%).

### High-contrast case

In the second example the conductivity of the scatterer is initially set to 0.01 S/m, which represents a strong contrast relative the background. We assume again a cost-function with a Hessian based on Eq.(7) and simulate changes in the scattered field in case the contrast changes between 1 and 5%. The relative errors in magnitude and phase when compared with the exact result are shown in Figures 4a and b. These errors are now seen to be erroneous: in the order of 83 - 84% for the magnitude and in the order of 14.5 - 15% for the phase.

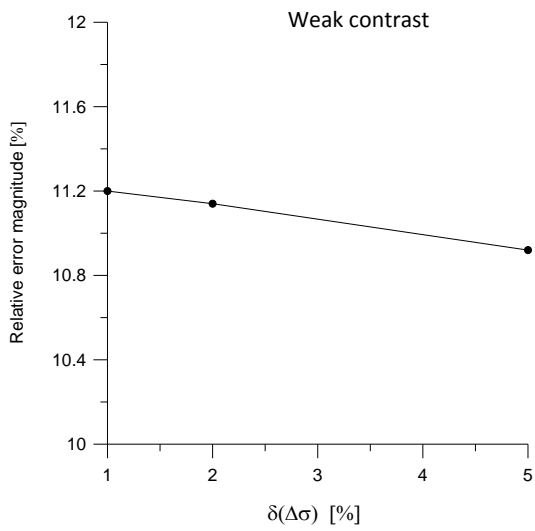

(a)

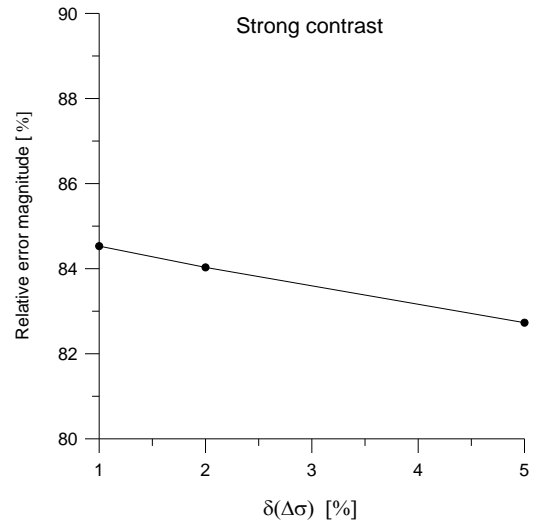

(a)

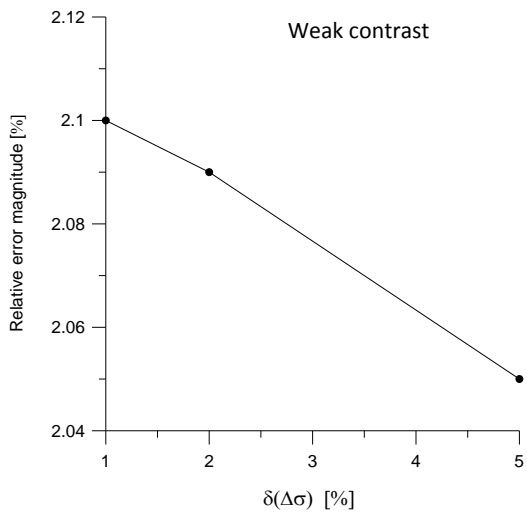

(b)

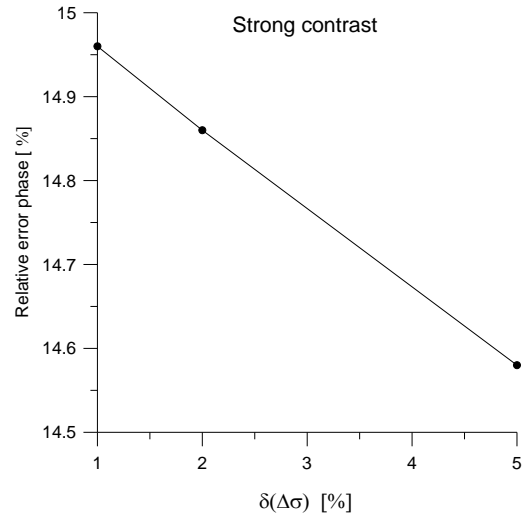

(b)

FIG.3 Relative errors in (a) magnitude and (b) phase. Low-contrast case.

FIG.4 Relative errors in (a) magnitude and (b) phase. High-contrast case.

### Extended Born versus Born

In this section a direct comparison between the EB and Born approximations is carried out. We employ the same test model as sketched in Fig.2 and consider again the inline electric field component calculated for a receiver placed at the origin. This time we allow the conductivity of the scatterer to vary within a large range of values: i.e.

$0.001 \leq \sigma \leq 0.49$  [S/m].. Scattered fields are computed based on respectively Eq.(7) (Born) and Eq.(8) (combined with Eq.(1)) (EB). Both results are compared with the exact solution and relative errors are calculated.

Figures 5a and b show the relative errors in respectively magnitude and phase in case of the Born approximation. At both moderate and larger contrasts these errors are very large as expected. Figures 6a and b show the corresponding results in case of the Extended Born approximation. The errors have now been reduced significantly and for most contrasts the relative error level is between 2 – 4% for the magnitude and less than 1% for the phase.

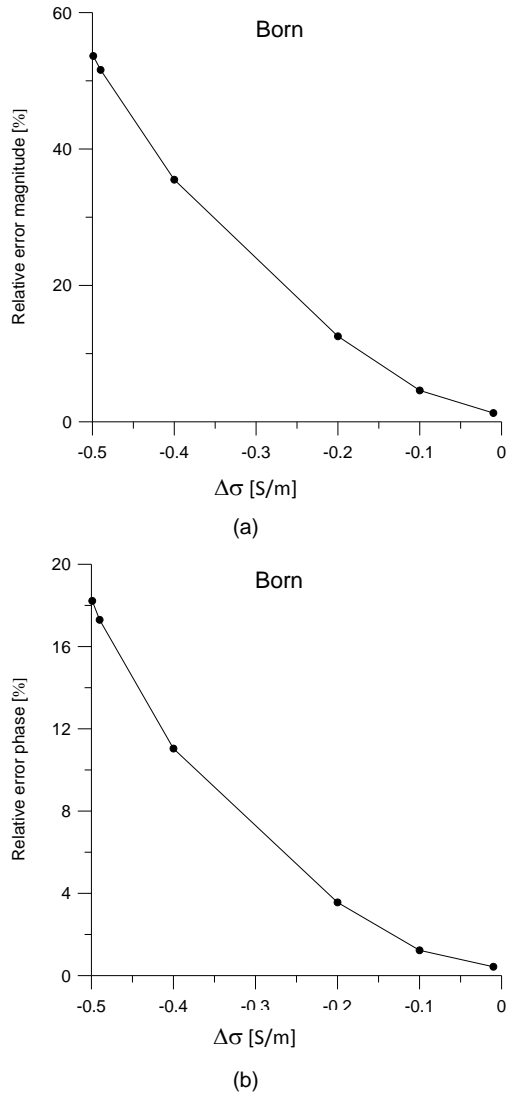
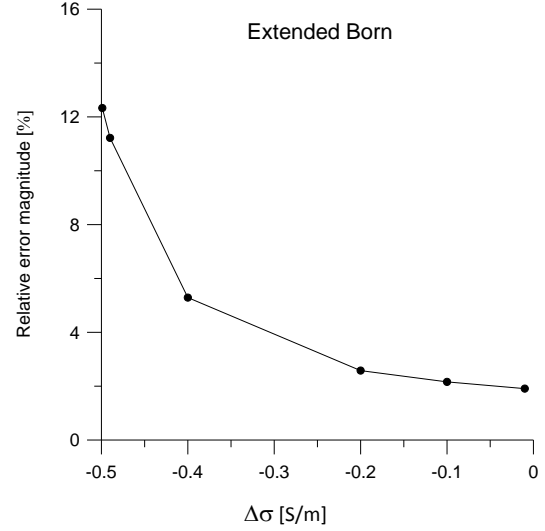
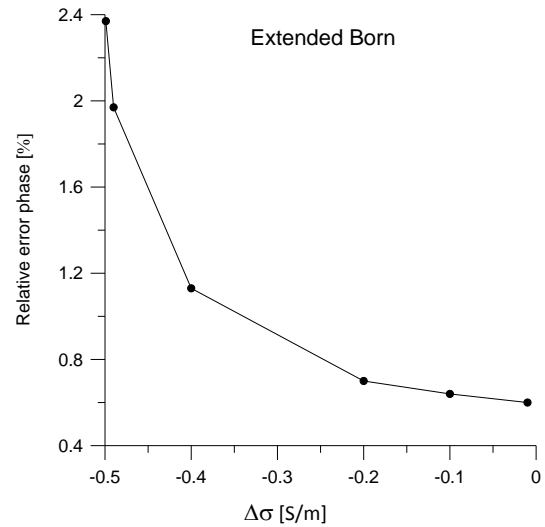

FIG.5 Relative error in (a) magnitude and (b) phase in case of Born approximation.



(a)



(b)

FIG.6 Relative error in (a) magnitude and (b) phase in case of Extended Born approximation.

### Fréchet derivative in case of EB

For completeness we will now derive the Fréchet derivative to be used in case of Extended Born. Combining Eqs.(1) and (8) gives

$$\bar{E}(\vec{r}) = \bar{E}_b(\vec{r}) + \int_D \bar{G}_e(\vec{r}, \vec{r}_0) \Delta\bar{\sigma}(\vec{r}_0) \bar{\Gamma}(\vec{r}_0) \bar{E}_b(\vec{r}_0) d\vec{r}_0 \quad (12)$$

From Eq.(12) it follows that (considering a change in volume cell  $j$  with center point  $\bar{r}_j$ )

$$\frac{\partial \bar{E}(\bar{r})}{\partial(\Delta \bar{\sigma}(\bar{r}_j))} \cong [\bar{G}_e(\bar{r}, \bar{r}_j) \bar{\Gamma}(\bar{r}_j) + \bar{K}(\bar{r}, \bar{r}_j)] \bar{E}_b(\bar{r}_j) \quad (13)$$

where

$$\bar{K}(\bar{r}, \bar{r}_j) = \int_D \bar{G}_e(\bar{r}, \bar{r}_0) \Delta \bar{\sigma}(\bar{r}_0) \frac{\partial \bar{\Gamma}(\bar{r}_0)}{\partial(\Delta \bar{\sigma}(\bar{r}_j))} \frac{\bar{E}_b(\bar{r}_0)}{\bar{E}_b(\bar{r}_j)} d\bar{r}_0 \quad (14)$$

From Eqs.(9) and (10) it follows that

$$\frac{\partial \bar{\Gamma}(\bar{r}_0)}{\partial(\Delta \bar{\sigma}(\bar{r}_j))} = \left( \bar{I} - G_D(\Delta \bar{\sigma}(\bar{r}_0)) \right)^{-2} \frac{\partial G_D(\Delta \bar{\sigma}(\bar{r}_0))}{\partial(\Delta \bar{\sigma}(\bar{r}_j))} = \bar{\Gamma}^2(\bar{r}_0) \bar{G}_e(\bar{r}_0, \bar{r}_j) \quad (15)$$

Finally, by combining Eqs.(14) and (15) we obtain this expression for  $\bar{K}$

$$\bar{K}(\bar{r}, \bar{r}_j) = \int_D \bar{G}_e(\bar{r}, \bar{r}_0) \Delta \bar{\sigma}(\bar{r}_0) \bar{\Gamma}^2(\bar{r}_0) \bar{G}_e(\bar{r}_0, \bar{r}_j) \psi(\bar{r}_0, \bar{r}_j) d\bar{r}_0 \quad (16)$$

where

$$\psi(\bar{r}_0, \bar{r}_j) = \frac{\bar{E}_b(\bar{r}_0)}{\bar{E}_b(\bar{r}_j)} = \frac{\bar{E}_b(\bar{r}_0) \bar{E}_b^H(\bar{r}_j)}{\bar{E}_b^H(\bar{r}_j) \bar{E}_b(\bar{r}_j)} \quad (17)$$

Both terms in the Frechet derivative in Eq.(13) are *now contrast dependent* unlike the Born approximation (cf. Eq.(11)).

In the limit of  $\bar{\Gamma} \rightarrow \bar{I}$ , Eq.(13) takes the form of Eq.(11) as it should.

## Conclusions

This paper has investigated how accurate the Born approximation is when used as part of a cost function for inversion of mCSEM data. The analysis has been carried out employing simple numerical models, and even for such idealized cases the Born model is shown to be very inaccurate. Moreover, the corresponding Frechet derivative within a Born approximation is shown to be independent of the contrast of the anomalous (scatterer) region. A much improved result can be obtained if the Extended Born approximation is being employed. It represents a rather modest increase in computational effort and ensures a significant improvement in accuracy. It is also shown that in case of the Extended Born approximation the corresponding Frechet derivative is contrast dependent as it should be from a physical point of view.

## Acknowledgments

We thank the following institutions for support: Science Foundation of the State of São Paulo (FAPESP), Brazil (LJG), Petrobras-SCTC/Cepetro (MT), and the National Council for Scientific and Technologic Development (CNPq), Brazil (MT).

## References

- Born, M., Optics, Springer-Verlag, New York, 1933.
- Eidesmo, T., S. Ellingsrud, L. M. MacGregor, S. Constable, M. C. Sinha, S. Johansen, F. N. Kong, and H. Westerdaal, "Sea Bed Logging (SBL), a new method for remote and direct identification of hydrocarbon filled layers in deepwater areas," *First Break*, Vol. 20, No. 3, 144–152, 2002.
- Gelius, L.-J., "Electromagnetic scattering approximations revisited", *Progress In Electromagnetic Research, PIER* 76, 75-94, 2007.
- Gribenko, A., and M.S. Zhdanov, "Rigorous 3D inversion of marine CSEM data based on the integral equation method", *Geophysics*, V.72, 229-254, 2007.
- Habashy, T. M., R. W. Groom, and B. Spies, "Beyond the Born and Rytov approximations: A non-linear approach to electromagnetic scattering," *J. Geophys. Res.*, Vol. 98, No. B2, 1759–1775, 1993.
- Hohmann, G. W., "Three-dimensional induced polarization and electromagnetic modeling," *Geophys.*, Vol. 40, No. 2, 309–324, 1975.
- Pankratov, O. V., D. B. Avdeev, and A. V. Kuvshinov, "Electromagnetic field scattering in a heterogeneous earth: A solution to the forward problem," *Physics of the Solid Earth*, (English edition), Vol. 31, 201–209, 1995.
- Singer, B. S. and E. B. Fainberg, "Generalization of the iterative-dissipative method for modeling electromagnetic fields in nonuniform media with displacement currents," *J. Appl. Geophys.*, Vol. 34, 41–46, 1995.
- Song, L.-P. and Q. H. Liu, "A new approximation to three-dimensional electromagnetic scattering," *IEEE Geosci. Remote Sens. Letters*, Vol. 2, No. 2, 238–242, 2005.
- Yuan, H., T. Pham, J.J. Zach, M.A. Frenkel and D. Ridyard, "Exploration case studies in mature Gulf of Mexico basins using 3D marine CSEM", *SEG Extended Abstract*, 2009.
- Zhdanov, M. S., V. I. Dmitriev, S. Fang, and G. Hursan, "Quasi-analytical approximation and series in 3D electromagnetic modeling," *Geophysics*, Vol. 65, 1746–1757, 2000
- Zhigang, W., H. Zhanxiang, S. Weibin, W. Yongtao and L. Weifeng, "Born approximation inversion for the marine CSEM data set", *SEG Extended Abstract*, Las Vegas, USA, 2008.